

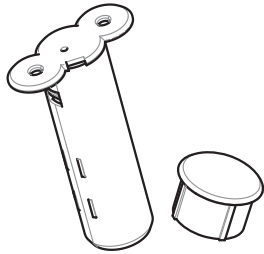

Recessed Door Sensor

View the expanded manual:
<http://aeot.ec/spprt/recessed>



1 Aeotec Recessed Door Sensor

From Aeotec by Aeon Labs' Intelligence series comes the Recessed Door Sensor. Invisibly installed, it sits within a door and its frame to provide all the information needed by a Z-Wave system for security, safety, and ambiance, and it does it all without altering a room's aesthetics.

2 Familiarise yourself with your door sensor

Your Recessed Door Sensor is comprised of two parts: the larger Main Sensor and the smaller Magnetic Sensor.

The larger Main Sensor

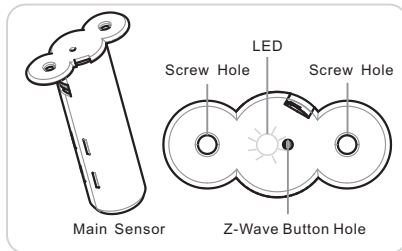

The Magnetic Sensor

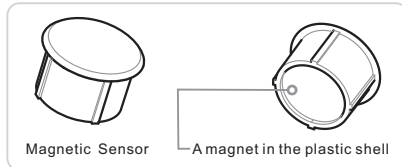

3 Quick Start

The installation of your Recessed Door Sensor has two major steps: the installation of the Main Sensor and the installation of the Magnetic Sensor. Powered by batteries, your door sensor will communicate with your Z-Wave network by using wireless technology after installation.

Prepare the Main Sensor

The first step in installing your Recessed Door Sensor is to activate the Main Sensor.

- Using a slot-head screwdriver, remove the Main Sensor's lid by pressing gently against its exposed connector.

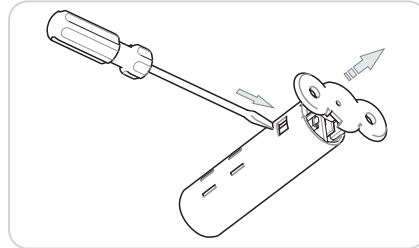

- Separate the Main Sensor's two sections by first removing its lid and then removing its internal components.

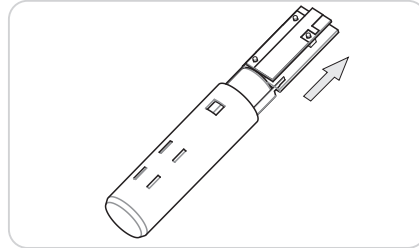

- Remove the clear battery insulator by pulling it away from the Main Sensor.

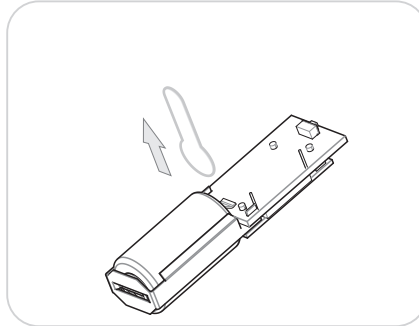

- With the battery insulator removed, reinsert the internal components into the Main Sensor's enclosure before reattaching its lid. The Main Sensor will now look as it did prior to step 1.

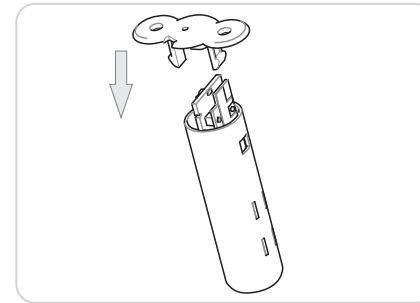

Note: Ensure that the Main Sensor's button is parallel to the button hole of its lid.

Install your Recessed Door Sensor

With the Main Sensor powered and activated, it is now time to inlay it within your selected doorframe and to also install the Magnetic Sensor.

Before getting started, it is important to select a suitable position for your Recessed Door Sensor. For the following instructions, your Recessed Door Sensor should be:

- Installed at the top of a door or the side of door.
- Positioned away from metal that could interfere with its magnetic functionality. This includes your door's plate, handle or lock mechanism.
- Installed in a suitable location to ensure a clear (at least 1mm) separation when the door is closed.
- Positioned exactly above or beside the hole you will later drill into your door for the installation of the Magnetic Sensor.

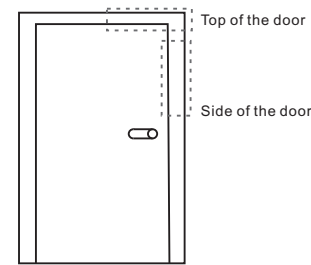

The rectangular areas highlighted above are the most appropriate installation positions.

Step 1

Prepare a space for the Main Sensor by drilling a hole into your doorframe using a 19mm wide drill bit. The hole should be 65 mm deep.

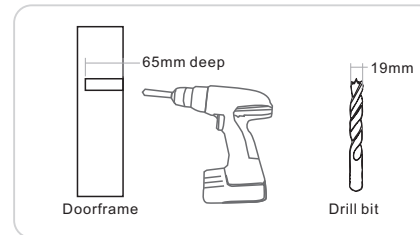

Step 2

Drill a corresponding hole in your door. The hole should be 15 mm deep. As stated, the position of this hole should align exactly with the hole you have just created in the doorframe. Again, use a 19mm wide drill bit.

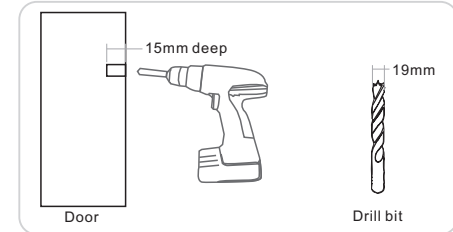

With your door and doorframe prepared and the drill holes created, it's now time to mount both parts of your Recessed Door Sensor.

Step 3

Insert the Main Sensor into the hole you created in the doorframe then secure it using two screws.

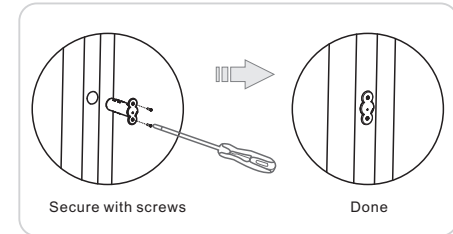

Step 4

Place a small amount of white glue (PVA) inside the hole you created for the Magnetic Sensor. Then place the sensor over and into the hole, and insert it by tapping gently on it with a rubber hammer.

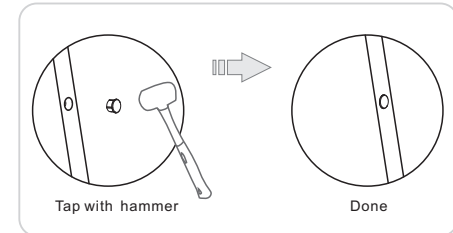

Step 5

The gap between the two parts of your sensor must be at least 1mm. If they are not, reconnect the Main Sensor potentially by altering its hole.

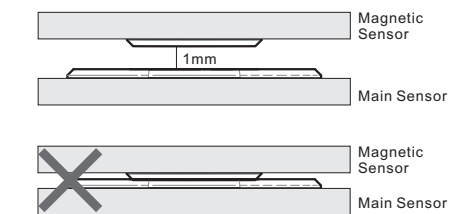

4 Add your sensor to your Z-Wave network

With your Recessed Door Sensor installed within a door and its frame, it's time to add it to your Z-Wave network. The following instructions tell you how to do this using Aeotec's Z-Stick and Minimote controllers. If you are using other products as your main Z-Wave controller, please refer to the part of their respective manuals that tells you how to add new devices to your network.

• If you are using a Z-Stick:

1. If your Z-Stick is plugged into a gateway or a computer, unplug it.
2. Take your Z-Stick to the door in which your Recessed Door Sensor has been installed.
3. Press the Action Button on your Z-Stick.
4. Press the Z-Wave Button on your Main Sensor with a small pin or toothpick.
5. If your Recessed Door Sensor has been successfully linked to your network, the LED light will stay solid for 10 minutes. If the linking was unsuccessful, the LED light will be blinking for 8 seconds before turning off.
6. Press the Action Button on the Z-Stick to take it out of installation mode.

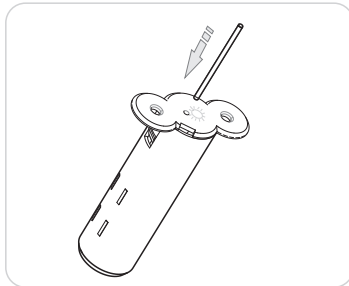
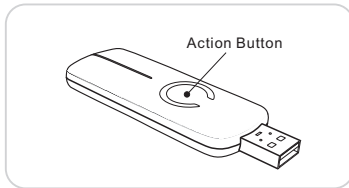

• If you are using a Minimote:

1. Take your Minimote to the door in which your Recessed Door Sensor has been installed.
2. Press the Include button on your Minimote.
3. Press the Z-Wave Button on your Main Sensor with a small pin or toothpick.
4. If your Recessed Door Sensor has been successfully linked to your network, the LED light will stay solid for 10 minutes. If the linking was unsuccessful, the LED light will be blinking for 8 seconds before turning off.
5. Press any button on your Minimote to take it out of installation mode.

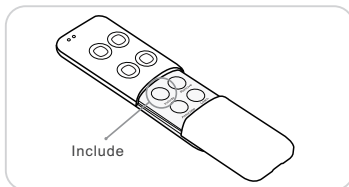

5 Removing your sensor from your Z-Wave network

Your sensor can be removed from your Z-Wave network at any time. You'll need to use your Z-Wave network's main controller to do this. The following instructions tell you how to do this using Aeotec by Aeon Labs' Z-Stick and Minimote controllers. If you are using other products as your main Z-Wave controller, please refer to the part of their respective manuals that tells you how to remove devices from your network.

• If you're using a Z-Stick:

1. If your Z-Stick is plugged into a gateway or a computer, unplug it.
2. Take your Z-Stick to your Recessed Door Sensor. Hold the Action Button on your Z-Stick for 3 seconds.
3. Press the Z-Wave Button on your Main Sensor with a small pin or toothpick.
4. If your Recessed Door Sensor has been successfully removed from your network, the LED light will turn off. If the removal was unsuccessful, the LED light will remain illuminated.
5. Press the Action Button on your Z-Stick to take it out of removal mode.

• If you're using a Minimote:

1. Take your Minimote to your Recessed Door Sensor.
2. Press the Remove button on your Minimote.
3. Press the Z-Wave Button on your Recessed Door Sensor with a small pin or toothpick.
4. If your Recessed Door Sensor has been successfully removed from your network, the LED light will turn off. If the removal was unsuccessful, the LED light will remain illuminate.
5. Press any button on your Minimote to take it out of removal mode.

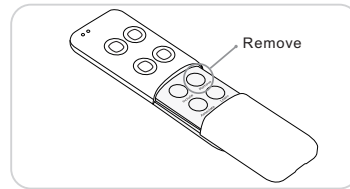

6 Technical Specifications

Operating distance: Up to 100 feet / 30 meters indoors and 300 feet / 100 meters outdoors.

Battery: lithium cell CR2, 3 volt battery, 800mAh.

Operating temperature: -10°C to 60°C.

Relative humidity: 8%~80%.

7 Warranty

Aeon Labs warrants to the original purchaser of Products that for the Warranty Period (as defined below), the Products will be free from material defects in materials and workmanship. The foregoing warranty is subject to the proper installation, operation and maintenance of the Products in accordance with installation instructions and the operating manual supplied to Customer. Warranty claims must be made by Customer in writing within thirty (30) days of the manifestation of a problem. Aeon Labs' sole obligation under the foregoing warranty is, at Aeon Labs' option, to repair, replace or correct any such defect that was present at the time of delivery, or to remove the Products and to refund the purchase price to Customer.

The "Warranty Period" begins on the date the Products is delivered and continues for 12 months.

Any repairs under this warranty must be conducted by an authorized Aeon Labs service representative and under Aeon Labs' RMA policy. Any repairs conducted by unauthorized persons shall void this warranty.

Excluded from the warranty are problems due to accidents, acts of God, civil or military authority, civil disturbance, war, strikes, fires, other catastrophes, misuse, misapplication, storage damage, negligence, electrical power problems, or modification to the Products or its components.

Aeon Labs does not authorize any person or party to assume or create for it any other obligation or liability in connection with the Products except as set forth herein.

Aeon Labs will pass on to Customer all manufacturers' Material warranties to the extent that they are transferable, but will not independently warrant any Material.

Customer must prepay shipping and transportation charges for returned Products, and insure the shipment or accept the risk of loss or damage during such shipment and transportation. Aeon Labs will ship the repaired or replacement products to Customer freight prepaid.

Customer shall indemnify, defend, and hold Aeon Labs and Aeon Labs' affiliates, shareholders, directors, officers, employees, contractors, agents and other representatives harmless from all demands, claims, actions, causes of action, proceedings, suits, assessments, losses, damages, liabilities, settlements, judgments, fines, penalties, interest, costs and expenses (including fees and disbursements of counsel) of every kind (i) based upon personal injury or death or injury to property to the extent any of the foregoing is proximately caused either by a defective product (including strict liability in tort) or by the negligent or willful acts or omissions of Customer or its officers, employees, subcontractors or agents, and/or (ii) arising from or relating to any actual or alleged infringement or misappropriation of any patent, trademark, mask work, copyright, trade secret or any actual or alleged violation of any other intellectual property rights arising from or in connection with the products, except to the extent that such infringement exists as a result of Aeon Labs' manufacturing processes.

IN NO EVENT SHALL AEON LABS BE LIABLE FOR ANY INDIRECT, INCIDENTAL, PUNITIVE, SPECIAL OR CONSEQUENTIAL DAMAGES, OR DAMAGES FOR LOSS OF PROFITS, REVENUE, OR USE INCURRED BY CUSTOMER OR ANY THIRD PARTY, WHETHER IN AN ACTION IN CONTRACT, OR TORT, OR OTHERWISE EVEN IF ADVISED OF THE POSSIBILITY OF SUCH DAMAGES. AEON LABS' LIABILITY AND CUSTOMER'S EXCLUSIVE REMEDY FOR ANY CAUSE OF ACTION ARISING IN CONNECTION WITH THIS AGREEMENT OR THE SALE OR USE OF THE PRODUCTS, WHETHER BASED ON NEGLIGENCE, STRICT LIABILITY, BREACH OF WARRANTY, BREACH OF AGREEMENT, OR EQUITABLE PRINCIPLES, IS EXPRESSLY LIMITED TO, AT AEON LABS' OPTION, REPLACEMENT OF, OR REPAYMENT OF THE PURCHASE PRICE FOR THAT PORTION OF PRODUCTS WITH RESPECT TO WHICH DAMAGES ARE CLAIMED. ALL CLAIMS OF ANY KIND ARISING IN CONNECTION WITH THIS AGREEMENT OR THE SALE OR USE OF PRODUCTS SHALL BE DEEMED WAIVED UNLESS MADE IN WRITING WITHIN THIRTY (30) DAYS FROM AEON LABS' DELIVERY, OR THE DATE FIXED FOR DELIVERY IN THE EVENT OF NONDELIVERY.

THE INDEMNITY AND WARRANTY IN ABOVE ARE EXCLUSIVE AND IN LIEU OF ALL OTHER INDEMNITIES OR WARRANTIES, WHETHER EXPRESS OR IMPLIED, INCLUDING THE IMPLIED WARRANTIES OF MERCHANTABILITY AND FITNESS FOR A PARTICULAR PURPOSE.

• FCC NOTICE(for USA)

THE MANUFACTURER IS NOT RESPONSIBLE FOR ANY RADIO OR TV INTERFERENCE CAUSED BY UNAUTHORIZED MODIFICATIONS TO THIS EQUIPMENT. SUCH MODIFICATIONS COULD VOID THE USER'S AUTHORITY TO OPERATE THE EQUIPMENT.

This device complies with Part 15 of the FCC Rules. Operation is subject to the following two conditions:

1. This device may not cause harmful interference.
2. This device must accept any interference received, including interference that may cause undesired operation. This equipment has been tested and found to comply with the limits for a Class B digital device, pursuant to part 15 of the FCC Rules. These limits are designed to provide reasonable protection against harmful interference in a residential installation. This equipment generates, uses and can radiate radio frequency energy and, if not installed and used in accordance with the instructions, may cause harmful interference to radio communications. However, there is no guarantee that interference will not occur in a particular installation. If this equipment does cause harmful interference to radio or television reception, which can be determined by turning the equipment off and on, the user is encouraged to try to correct the interference by one or more of the following measures:

- Reorient or relocate the receiving antenna.
- Increase the separation between the equipment and receiver.
- Connect the equipment into an outlet on a circuit different from that to which the receiver is connected.
- Consult the dealer or an experienced radio/TV technician for help.

• Warning

Do not dispose of electrical appliances as unsorted municipal waste, use separate collection facilities.

Contact your local government for information regarding the collection systems available.

• Certifications (regional):



FCC ID: XBADSB54

Version:501005400001-AA

www.aeotec.com

